

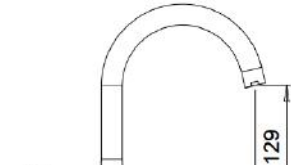
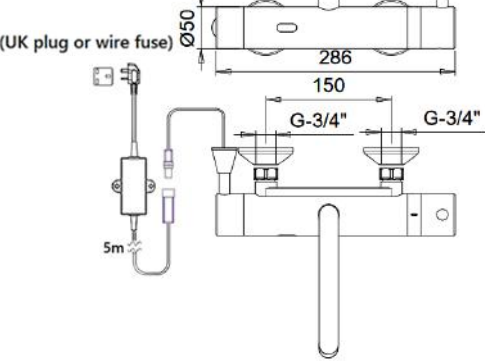

PROJECT		REF		REV	ITEM CODE	
LOCATION		DATE			PAGE	

SANITARY WARE SPECIFICATION SHEET

Item Descriptions	Stern (Israel) "Apollo Medical F" Chrome plated exposed wall-mounted thermostatic sensor mixer with gooseneck spout in AC Supply with 5m wire AC 110-240 Vac 50/60Hz to 9V 0.3A IP68 waterproof switching transformers	Illustration/ Drawing
Dimensions	L286 x W159 x H129 mm	  
Model	Apollo Medical FE	
Code Number	314540	
Finish	Chrome Plated	
Supplier	Acme Sanitary Ware Co. Ltd Mr. Eric Wong/ Mr. Don Yuen	
Contact Tel/Fax	(852) 2388-7171 / (852) 2710-8012	
E-mail	acme@acmesanitary.com.hk	
Website	www.acmesanitary.com.hk	

APOLLO MEDICAL FE Ref # 314540

Touch-free wall-mounted electronic faucet. For hot and cold water, includes a mixer for temperature adjustment. Gooseneck spout. Powered by a 9V transformer. Adjustable settings by remote control: security time, delay in, delay out, on-off and reset to factory settings.

Application:

Touch-free faucet. Enables patients and medical personnel to wash hands without touching the faucet. Prevents cross contamination. Helps washrooms to stay cleaner. Ideal for hospitals, laboratories, dental clinics and commercial kitchens.

Use:

Touch-free electronic faucet. The faucet is automatically activated when users place their hands in the sensor range and stops when users move away from the sensor range.

PRODUCT AT A GLANCE

Installation	Exposed wall-mounted				
Power Supply	<ul style="list-style-type: none"> • 9V battery • 9V transformer 				
Operating pressure	0.5-8.0 bar / 7.0-116.0 PSI				
Water supply	Hot and cold water				
Water flow	6 LPM / 1.58 GPM - SSR PCA stream				
Water Saving Options	4 LPM / 1 GPM ; 3 LPM / 0.8 GPM 1.89 LPM / 0.5 GPM ; 1.3 LPM 0.35 GPM - PCA spray				
Water temperature	70°C Maximum				
Security Time	90 seconds. Adjustable by remote control				

ORDERING INFORMATION				OPTIONS	
MODEL	CODE	POWER	ADDITIONAL FEATURES	OPTION	CODE
APOLLO MEDICAL FB	340530	9V battery	Exposed installation Gooseneck spout	Remote control	07100005
APOLLO MEDICAL FE	340540	9V transformer	Mixer for water temperature adjustment		



Installation:

Wall mounted exposed



Water supply:

Hot & Cold (2 inlets)



Water temperature:

Max. 65 °C



Operating pressure:

0.5 – 8.0 bar



Power source:

9V Transformer



Lead free:

Submitted

* All information of the above is for the reference only. No prior notice is made if any changes.



SPARE PARTS LIST

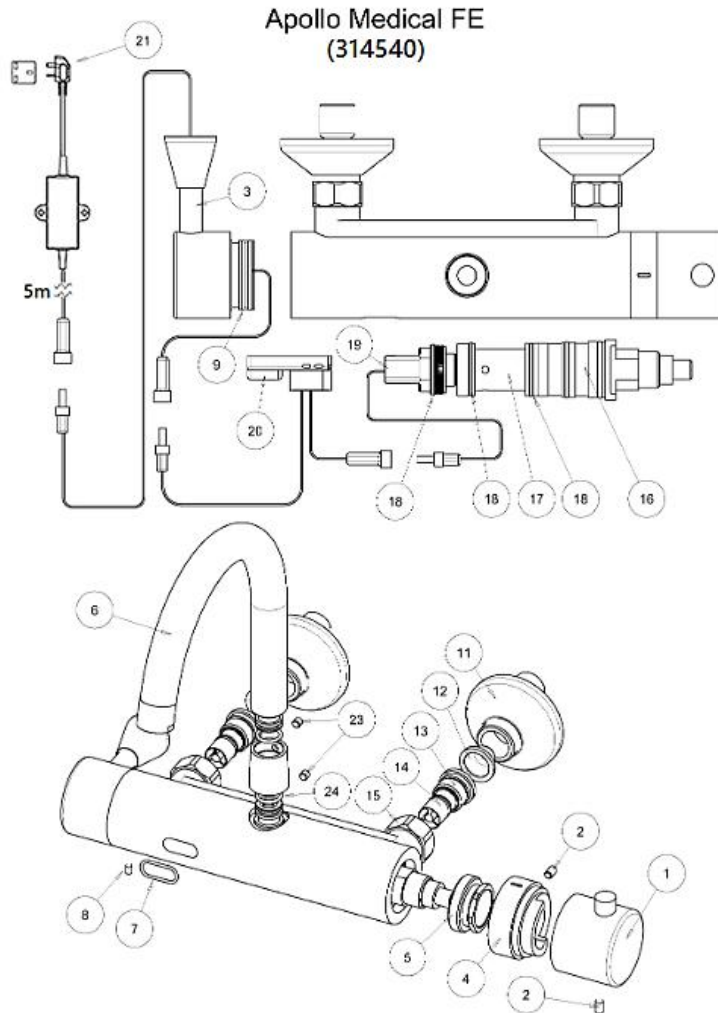

Quantity	Part Number	Description	Cat. No.
-	-	Seals and Screws Kit	07210144
1	7	O-ring	
2	9	O-ring	
2	2	Screw	
1	8	Screw	
2	24	O-ring	
2	23	Screw	
-	-	Sensor Kit	07220203
1	20	Infra Red Sensor	
1	7	O-ring	
-	-	Thermostatic Cartridge Kit	07240021
1	16	Thermostatic cartridge	
1	17	Adapter	
3	18	O-Ring	
1	1	Thermostatic Handle	07110018
19	19	Stern Interoperable LS9V1.2WWPC1	07500065
4	4	Adapter for Handle	07055067
5	5	Nut for Thermostat	07055070
6	6	Spout	07015006
3	3	Cover Kit	07270079
-	-	Inlet Nipple Kit	07246033
2	12	Flat filter	
2	13	Nipple	
2	14	Valve Check	
2	15	Nut 5/4"	
21	21	Transformer	TBC

Note: In order to locate the relevant spare part, please check the corresponding parts and part number in the drawing. Minimum order quantity will be required.

* All information of the above is for the reference only. No prior notice is made if any changes.



FAUCET INSTALLATION

STEP 1 – INSTALLING THE FAUCET

1

Shut off the water supply.

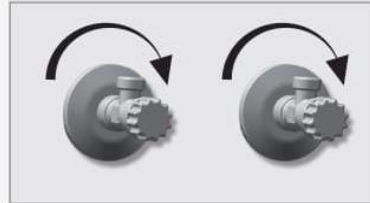

NOTE: The standard distance between the water supply pipes centers is 150 mm. Two eccentric unions are provided to allow variations from 130mm to 170mm.

2

Mount the eccentric unions on the water supply pipes.

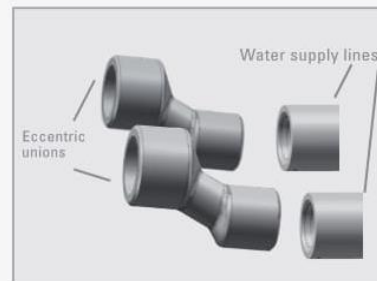

3

Apply the covering rosettes on the eccentric unions, and set the eccentric unions so that they correspond with the faucet inlets.

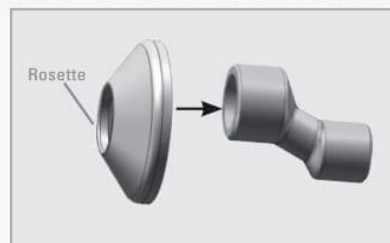

IMPORTANT: To make sure it will be installed in the right location, the filter is joined to the faucet nuts with a clear adhesive tape.

4

Remove the clear adhesive tape holding the filters in place.

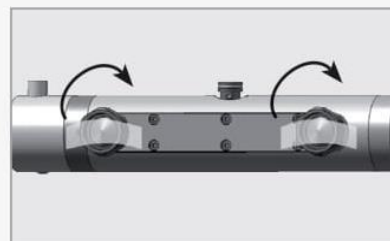



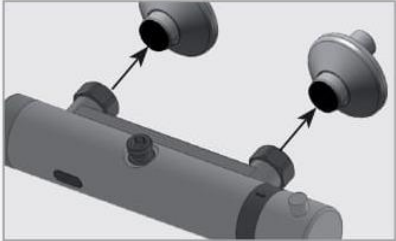
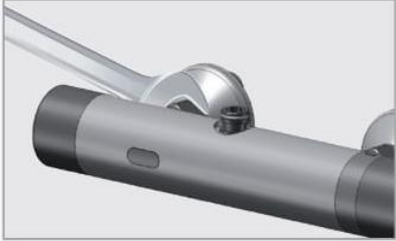
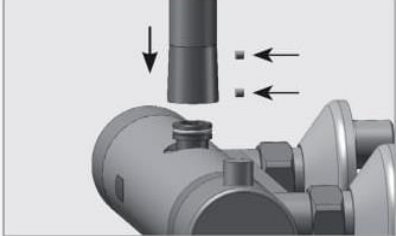

FAUCET INSTALLATION

<p>5</p>	<p>Proceed to mounting the faucet on the eccentric unions.</p>	
<p>6</p>	<p>Tighten the nuts carefully with a 30mm wrench.</p>	
<p>7</p>	<p>Mount the spout to its location in the faucet body, and tighten the Allen screw/s using the Allen key provided in the packaging.</p>	

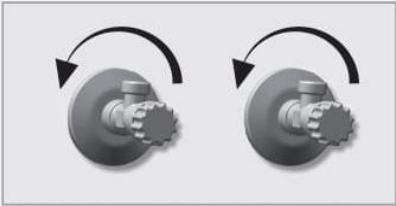
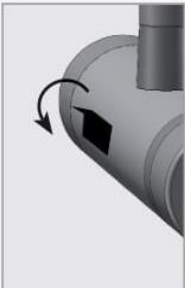
STEP 2 – CONNECTING THE WATER SUPPLY AND OPERATING THE FAUCET

<p>1</p>	<p>Turn on the central water supply and the shut-off valves and check for leaks.</p>	
<p>2</p>	<p>Remove the protective sticker that covers the sensor and wait 10 seconds before activating the faucet. IF THE RANGE IS UNSATISFACTORY, REFER TO THE SECTION TITLED “SETTING ADJUSTMENT”.</p>	 



ADJUSTING THE WATER TEMPERATURE

The faucet has been factory calibrated to 38°C under ideal installation conditions. Due to variations in site conditions, the mixed water temperature may need adjustments to match the site conditions and make sure that it is safe.

1

Unscrew the regulation knob screw and remove the regulation knob.

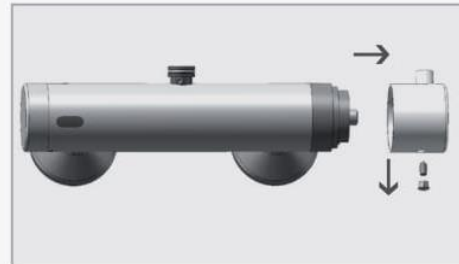

2

Proceed to achieve a 38°C settings by turning the spindle and measuring the water temperature with a thermometer.

NOTE: Make sure always to use a thermometer with proven accuracy.

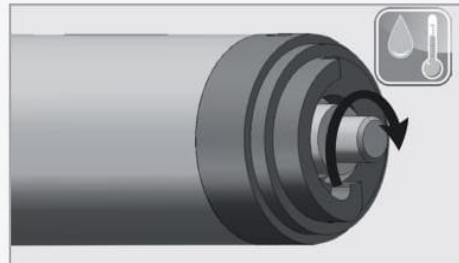

3

Assemble the regulation knob to the 38°C position. The anti scalding knob must correspond to the 38°C stop in the stop ring, without moving the spindle.

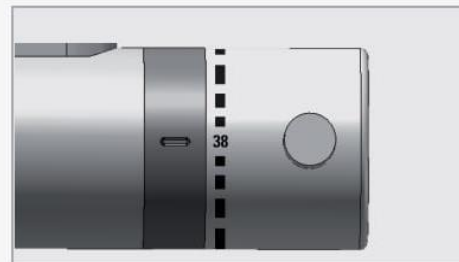

4

Screw the regulation knob screw and tighten it.

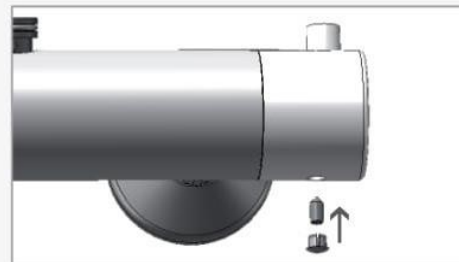

THE FAUCET IS NOW CALIBRATED ACCORDING TO THE SITE SPECIFIC CONDITIONS.



SERVICE CHECK LIST

PROBLEM	INDICATOR	CAUSE	SOLUTION
No water coming out of the faucet:	1. Sensor flashes continuously when user's hands are within the sensor's range.	Low battery.	Replace battery
	2. Red light in the sensor does not flash once when user's hands are within the sensor's range.	1. Range is too short.	Increase the range
		2. Range is too long.	Decrease the range
		3. Battery is completely used up	The battery must be replaced.
		4. Unit is in "Security Mode"	
	3. Red light in the sensor flashes once when user's hands are within the sensor's range.	5. Sensor is picking up reflections from the washbasin or another object.	Eliminate cause of reflection.
1. Debris or scale in solenoid.		Unscrew solenoid, pull out the plunger and the spring from the solenoid and clean them. Use scale remover material if needed. When replacing the plunger, please make sure that the spring is in vertical position.	
	2. The central orifice in the diaphragm is plugged or the diaphragm is torn	Clean the orifice or replace diaphragm.	
	3. The water supply pressure is higher than 8 bar.	Reduce the supply water pressure.	
	4. The water supply pressure is under 8 bars and yet the pressure in the faucet's body is higher. This situation could be caused by a sudden increase in the water supply pressure that the backcheck prevents from dropping, even after water supply pressure drops under 8 bars.	Shut off water supply and unscrew one of the flexible pipes in order to reduce the pressure that blocks the product.	
Water flow from spout does not stop:	1. Sensor flashes once when user's hands are within the sensor's range.	1. Debris or scale in diaphragm	Clean the orifice or replace diaphragm.
	2. Red light in the sensor does not flash once when user's hands are within the sensor's range.	2. Connectors between the electronic unit and the Dual power input box are disconnected or not connected properly	Connect the connectors properly. Refer to page 6 to see how.
		1. Sensor is dirty or covered.**	Clean or eliminate cause of interference.
		2. Sensor is picking up reflections from the washbasin or another object.	Decrease the range or eliminate cause of reflection.
Water flow diminished		Filter or aerator is clogged	Remove, clean, re-install

* "Security Mode": If the sensor is covered for more than 90 sec. the faucet will automatically shut off water flow. To return to normal operation remove any blockage.

** In this case, the water flow will stop anyway after 90 seconds because of the security time.